

PORTABLE EQUIPMENT

N600

- Multipurpose vibrometer
- Spectrum analyser
- Data collector
- Balancing machine



CEMB

BALANCING MACHINES

N600

CEMB – THE SOLUTION FOR ANALYSIS AND BALANCING FOR MORE THAN 60 YEARS

CEMB's range of portable equipment for vibration measurement and analysis, balancing and predictive maintenance has been enhanced with the new N600 instrument.

Equipped with an ample, backlit, high resolution LCD colour screen, N600 can be used in all types of lighting conditions.

Ease of use, calculation power and intuitive methods for the setting/presentation of measurements and graphs are the main features of this instrument.

The analysis functions provide the information needed for machine diagnosis and diagnosis of the condition of the bearings so the most appropriate maintenance work can be identified.

The balancing function can be used to balance any type of rotating body on one or more plane irrespective of size and weight.

The vibration trend over time, spectral analysis and Bode plot, which are essential tools for defining the corrective action needed with extreme precision, are all visible directly on the screen.

All of the readings taken can be saved in a database using sophisticated software for effective and rational organisation of predictive maintenance.

The equipment is supplied with standard accessories (2 accelerometers with a heavy-duty spiral cable, Hi-Speed 250,000 cpm photocell, USB stick, angle rule) sufficient for performing all of the main functions. Various optional accessories are also available (other types of sensors, extensions, Bluetooth printer) for when the equipment needs to be used in special conditions.

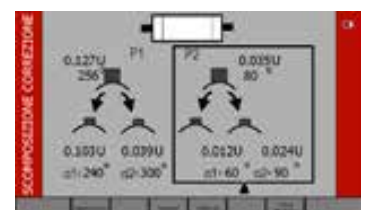
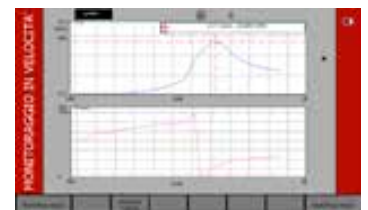
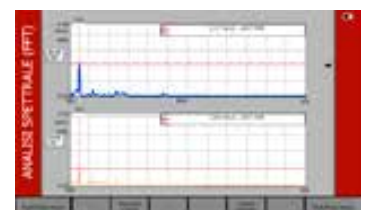
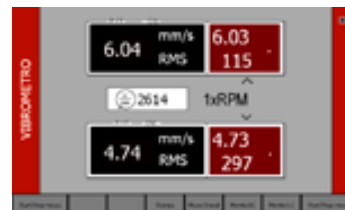

ADS ADVANCED DIAGNOSTIC SOFTWARE

The software package, which can be installed on a PC, can perform data acquisition route creation (Route Manager) functions and provides diagnostics tools (Advanced Diagnostic Software). Three different levels are available to meet all requirements: storage, detailed analysis, diagnostics, measurement comparisons, trends, spectrums, orbits.

LEVEL 1 BASIC

- Multilingual interface
- Trend data
- Route management
- Data export option
- Zoom

LEVEL 2 STANDARD

- All Level 1 functions plus:
- FFT analysis
 - Harmonic cursor
 - List of peak values
 - Waveform

LEVEL 3 EXPERT

- All Level 1 and 2 functions plus:
- Waterfall analysis
 - Orbit analysis
 - Bode plot
 - Nyquist plot
 - Statistical analysis

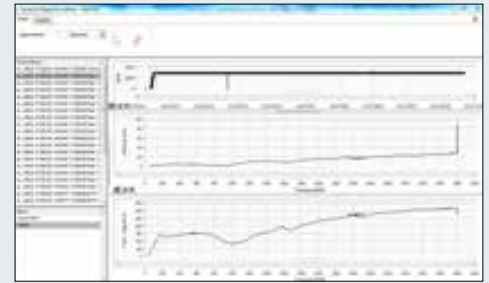
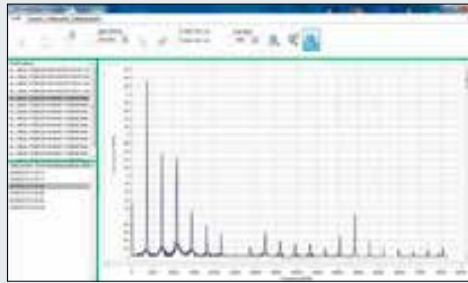
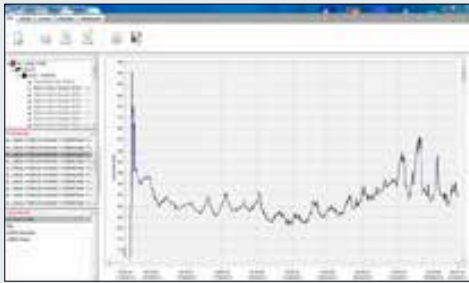

N600 VERSATILE AND COMPLETE

STANDARD ACCESSORIES:

- No. 2 accelerometer transducers 100mV/g
- No. 2 transducer connection cables L 2.5 m
- No. 1 heavy duty spiral cable L 2 m
- No. 2 magnetic bases Ø 25 mm
- No. 2 probes
- No. 1 250,000 Cpm Hi-speed, laser photocell complete with upright and magnetic base
- No. 1 roll of reflecting tape
- No. 1 USB stick for data transfer
- Angle rule
- Battery charger
- Universal plug
- Case complete with carry strap
- Manual

OPTIONAL ACCESSORIES:

- Bluetooth printer
- Protective cover
- Velocity transducer complete with lead and magnetic base
- Proximity sensor complete with upright, lead and magnetic base
- Connection cable for transducers L 5 m
- 10 m-long extension cable for transducers
- 10 m-long extension cable for photocell
- CEMB ADS software for data storage and management



TECHNICAL DATA

FUNCTIONS:

- Measurement of the overall vibration value (acceleration, velocity, displacement)
- Vibration phase measurement
- Analysis of vibration in the frequency range
- Monitoring overall vibration in relation to time or velocity (Bode plot)
- Balancing of rotating bodies in operating conditions on 1 or 2 planes
- Waveform

MEASUREMENT TYPES

- Effective value (RMS)
- Peak value (Pk)
- Peak-to-peak value (PP)

UNITS OF MEASUREMENT

- Acceleration: [g]
- Velocity: [mm/s] or [inch/s]
- Displacement: [μ m] or [mils]
- Frequency: [Hz] or [Cpm]

INPUT

- 2 independent and simultaneous measuring channels (accelerometer, velocimeter, non-contact, any signal max. 5V-PP)
- 1 photocell channel (velocity and angle reference)
- 2 USB ports for data transfer

VIBROMETER FUNCTION

- Measurement of the overall vibration value in predefined frequency bands (10-1000Hz; 3-300Hz; 10-10000Hz) or bands defined by the user (within the range of 3-20000Hz)
- Measurement of 1x fundamental vibration value and phase
- Measurement of rotating body velocity

FFT FUNCTION (ANALYSIS IN FREQUENCY)

- FFT analysis (manual/trigger)
- Maximum settable frequency (25; 100; 500; 1000Hz; 2.5; 5; 10; 15kHz)
- Resolution (100; 200; 400; 800; 1600; 3200 lines)
- Number of averages: from 1 to 16
- List of main peak values

MONITOR – DATA LOGGER FUNCTIONS

- Recording and display of overall vibration trend over time
- Storage and display of vibration trend and phase when rotation velocity changes.

BALANCING FUNCTION

- Number of correction planes: from 1 to 2
- Graphic indicator of measurement stability
- Balancing procedure, guided step by step, with option for editing and intermediate changes
- Vectorial breakdown of the unbalance
- Correction by adding or removing material

GENERAL CHARACTERISTICS

- Display: 7" colour LED-backlit TFT LCD
- A/D converter: 24 bit resolution
- Dimensions: approx. 225 x 200 x 50 mm
- Weight: 1.4 kg

OPERATING CONDITIONS

- Temperature: from -10° to +50° C
- Air humidity: from 0 to 95% without condensate

POWER SUPPLY

- Rechargeable 6Ah Lithium battery
- Charging time: < 5 hours (when battery is fully discharged)
- Power supply-battery charger for 100-240 V, 50/60 Hz (24 V, 1.5 A)
- Battery life: > 8 hours based on typical use



ITALIAN HEART:

All of the design and production is strictly MADE IN ITALY

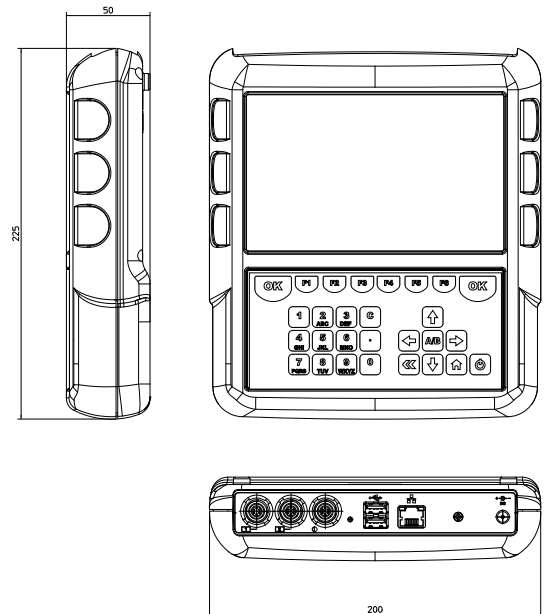

CEMB S.p.A.
Via Risorgimento, 9
23826 MANDELLO DEL LARIO (LC) Italy
www.cemb.com

 **Vibration analysis division:**
phone +39 0341 706111
fax +39 0341 706299
e-mail: stm@cemb.com

All of the data and characteristics mentioned in this catalogue are purely indicative and do not constitute a commitment for our company, which reserves the right to make any changes it may deem necessary without any prior warning.